

Tsurumi Submersible Pumps

OPERATION MANUAL

TSURUMI MANUFACTURING CO., LTD.

INTRODUCTION

Thank you for selecting the Tsurumi Submersible Pumps.

This operation manual explains the product operations and gives important precautions regarding its safe use. In order to use the product to maximum benefit, be sure to read the instructions thoroughly and follow them carefully.

To avoid accident, do not use the product in any way other than as described in this operation manual. Note that the manufacturer cannot be responsible for accidents arising because the product was not used as prescribed. After reading this operation manual, keep it nearby as a reference in case questions arise during use.

When lending this product to another party, always be sure to include this operation manual as well.

If this operation manual should become lost or damaged, ask your nearest dealer or Tsurumi representative for another copy.

Every effort has been made to ensure the completeness and accuracy of this document. Please contact your nearest dealer or Tsurumi representative if you notice any possible error or omission.

The contents of this document may not be copied in whole or in part without the express permission of Tsurumi Manufacturing Co., Ltd.

CONTENTS

1. BE SURE TO READ FOR YOUR SAFETY	1
2. PRIOR TO OPERATION	4
3. INSTALLATION	5
4. ELECTRICAL WIRING	8
5. OPERATION	9
6. MAINTENANCE AND INSPECTION	13
7. TROUBLESHOOTING	14

1 BE SURE TO READ FOR YOUR SAFETY

Be sure to thoroughly read and understand the SAFETY PRECAUTIONS given in this section before using the equipment in order to operate the equipment correctly.

The precautionary measures described in this section are intended to prevent danger or damage to you or to others. The contents of this manual that could possibly be performed improperly are classified into two categories: **⚠ WARNING**, and **⚠ CAUTION**. The categories indicate the extent of possible damage or the urgency of the precaution. Note however, that what is included under **⚠ CAUTION** may at times lead to a more serious problem. In either case, the categories pertain to safety-related items, and as such, must be observed carefully.

- **⚠ WARNING** : Operating the equipment improperly by failing to observe this precaution may possibly lead to death or injury to humans.
- **⚠ CAUTION** : Operating the equipment improperly by failing to observe this precaution may possibly cause injury to humans and other physical damage.
- **NOTE** : Gives information that does not fall in the WARNING or CAUTION categories.
- **Explanation of Symbols:**



: The \triangle mark indicates a WARNING or CAUTION item. The symbol inside the mark describes the precaution in more detail ("electrical shock", in the case of the example on the left).



: The \circ mark indicates a prohibited action. The symbol inside the mark, or a notation in the vicinity of the mark describes the precaution in more detail ("disassembly prohibited", in the case of the example on the left).



: The \bullet mark indicates an action that must be taken, or instructs how to perform a task. The symbol inside the mark describes the precaution in more detail ("provide ground work", in the case of the example on the left).

PRECAUTIONS TO THE PRODUCT SPECIFICATIONS









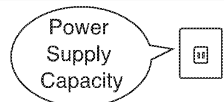
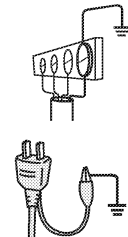
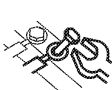

⚠ CAUTION	
	<ul style="list-style-type: none"> ● Do not operate the product under any conditions other than those for which it is specified. Failure to observe the precaution can lead to electrical leakage, electrical shock, fire, or other problems.









PRECAUTIONS DURING TRANSPORT AND INSTALLATION







⚠ WARNING	
	<ul style="list-style-type: none"> ● When transporting the product, pay close attention to its center of gravity and mass. Use an appropriate lifting equipment to lift the unit. Improper lifting may result in the product damage, injury, or death.
	<ul style="list-style-type: none"> ● Install the product properly in accordance with this operation manual. Improper installation may result in electrical leakage, electrical shock, fire, or injury.
	<ul style="list-style-type: none"> ● Electrical wiring should be performed in accordance with all applicable regulations in your country. Absolutely provide a dedicated earth leakage circuit breaker and a thermal overload relay suitable for the product (available on the market). Imperfect wiring or improper protective equipment can lead to electrical leakage, fire, or explosion in the worst case.
	<ul style="list-style-type: none"> ● Provide a secure grounding dedicated for the product. Never fail to provide an earth leakage circuit breaker and a thermal overload relay in your starter or control panel (Both available on the market). If an electrical leakage occurs by due to a product failure, it may cause electrical shock.
	<ul style="list-style-type: none"> ● Use a power outlet that has a sufficient rating and has been exclusively provided for the pump. If the power outlet is shared with other equipment, it can lead to an abnormal heat of the outlet and can cause fire as a result.









 CAUTION		
	<ul style="list-style-type: none"> ● Be sure to provide a ground wire securely. Do not connect the ground wire to a gas pipe, water pipe, lightning rod, or telephone ground wire. Improper grounding could cause electrical shock. 	<ul style="list-style-type: none"> ● Prevent a metallic object or dust from sticking to the power plug. Adhesion of foreign object to the plug could cause electrical shock, short-circuit, or fire. 
	<ul style="list-style-type: none"> ● Do not scratch, fold, twist, make alterations, or bundle the cable, or use it as a lifting device. The cable may be damaged, which may cause electrical leakage, short-circuit, electrical shock, or fire. 	<ul style="list-style-type: none"> ● Do not use the cable, power plug, or power outlet if it is damaged or it is not closely fitted. Connect every conductor of the cable securely to the terminals. Failure to observe this can lead to electrical shock, short-circuit, or fire. 
	<ul style="list-style-type: none"> ● When transporting or installing the pump, attach a wire rope or chain firmly to the eyebolt. Do not under any circumstances install or transport the pump by suspending it from the cable. The cable may be damaged, which may cause electrical leakage, electrical shock, or fire. 	<ul style="list-style-type: none"> ● When the product will be carried by hand, decide the number of persons considering the mass of the product. When lifting up the product, do not attempt to do it by simply bowing from the waist. Use the knees, too, to protect your waist. 
	<ul style="list-style-type: none"> ● This product is neither dust-proof nor explosion-proof. Do not use it at a dusty place or at a place where corrosive, toxic or explosive gas presents or may be generated. Use in such places could cause fire or explosion. 	<ul style="list-style-type: none"> ● Install the discharge piping securely so that no water leakage may occur. Failure to do so may result in damage to nearby walls, floors, and other equipment.
	<ul style="list-style-type: none"> ● Let the unit suck minimum amount of sand or mud. When the pump is to be installed on a soft foundation, mount it on a concrete block or the like to prevent it from being submerged in sand. Damage resulting from abrasion may bring about electrical leakage or electrical shock. 	<ul style="list-style-type: none"> ● If a hose is used for the discharge line, take a measure to prevent the hose from shaking. If the hose shakes, you may be wet or injured.

PRECAUTIONS DURING TEST OPERATION AND OPERATION



 WARNING		
	<ul style="list-style-type: none"> ● Never start the pump if somebody is present in the pump sump. If an electrical leakage occurs, it can cause electrical shock. 	
	<ul style="list-style-type: none"> ● Never start the pump while it is suspended, as the unit may jerk and lead to injury. 	
 CAUTION		
	<ul style="list-style-type: none"> ● Do not operate the product under any voltage other than described on the nameplate with the voltage tolerance limit within $\pm 5\%$. If it is operated with a generator, it is strongly suggested not to operate other equipment with the same generator. Failure to observe this caution may cause malfunction and breakdown of the product, which may lead to electrical leakage or electrical shock. 	
		<ul style="list-style-type: none"> ● Check that the motor rotates in the correct direction of rotation. Operating in the wrong direction may damage the pump, which may cause electrical leakage or electrical shock.

 CAUTION			
	<ul style="list-style-type: none"> Do not run the product dry or operate it with its maximum head, as doing so will damage the product, which may lead to electrical leakage or electrical shock. 		<ul style="list-style-type: none"> Do not use the product in a liquid other than water. Use in oil, salt water or organic solvents will damage it, which may lead to electrical leakage or electrical shock.
	<ul style="list-style-type: none"> Do not use the product in hot or warm liquid over 40°C, as doing so will damage the product, which may lead to electrical leakage or electrical shock. 		<ul style="list-style-type: none"> Do not touch the product with bare hands during or after the operation, as the product may become very hot during operation. Failure to observe this caution may lead to be burned.
	<ul style="list-style-type: none"> Never insert a finger or any other object into the pump inlet holes. Failure to observe this caution may lead to injury. 		<ul style="list-style-type: none"> When the product will not be used for an extended period, be sure to turn off the power supply (earth leakage circuit breaker, etc.). Deterioration of the insulation may lead to electrical leakage, electrical shock, or fire.



PRECAUTIONS DURING MAINTENANCE AND INSPECTION

 WARNING			
	<ul style="list-style-type: none"> Absolutely turn off the power supply and make sure that the impeller has stopped completely before starting maintenance or inspection. Failure to observe this caution may lead to death or major accident. 		<ul style="list-style-type: none"> Do not disassemble or repair any parts other than those designated in the operation manual. If repairs are necessary in any other than the designated parts, consult with the dealer where it was purchased or Tsurumi representative. Improper repairs can result in electrical leakage, electrical shock, or fire.
	<ul style="list-style-type: none"> In case any abnormality (excessive vibration, unusual noise or odor) is found in the operation, turn the power off immediately and consult with the dealer where it was purchased or Tsurumi representative. Continuing to operate the product under abnormal conditions may result in electrical shock or fire. 		
 CAUTION			
	<ul style="list-style-type: none"> After reassembly, always perform a test operation before resuming use of the product. Improper assembly can result in electrical leakage, electrical shock, or fire. 		

PRECAUTION TO POWER OUTAGE

 WARNING			
	<ul style="list-style-type: none"> In case of power outage, turn off the power supply. The product will resume operation when the power is restored, which presents serious danger to people in the vicinity. 		power outage OFF

OTHER PRECAUTION

 CAUTION			
	<ul style="list-style-type: none"> Never use the product for potable water. It may present a danger to human health. 		Potable Water

2 PRIOR TO OPERATION

Check the following points after unpacking the package:

Inspecting the Product

Verify that no damage has occurred to the pump during shipment and that the bolts and nuts have not loosened.

A certain automatic pump has a piece of tape affixed to the float case, in order to prevent it from becoming detached during transport. Please remove the tape before using the pump.

Inspecting the Specifications

Check the nameplate of the pump unit to verify that it is the product that you have ordered. Pay particular attention to its voltage and frequency specifications.

Note: *If you discover any damage or discrepancy, please contact with the Tsurumi dealer from whom you purchased the product or the nearest Tsurumi representative office.*

Example of nameplate

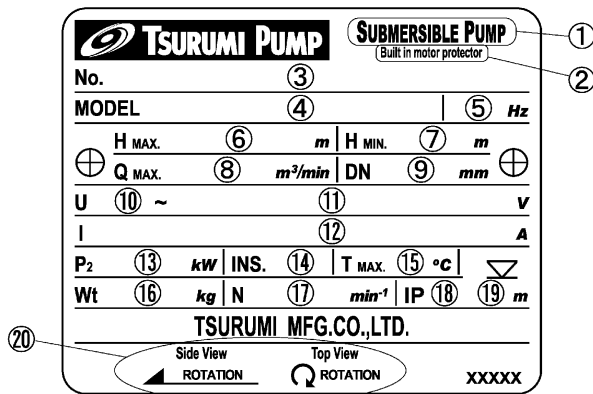

1	Submersible pump	11	Rated voltage
2	Built in motor protector	12	Rated current
3	Serial number	13	Rated output power
4	Model	14	Insulation class
5	Frequency	15	Max. liquid temperature
6	Max. total head	16	Weight without cable
7	Min. total head	17	Speed of rotation
8	Max. flow rate	18	IP degree of protection
9	Discharge bore	19	Max. immersion depth
10	Phase	20	Direction of rotation

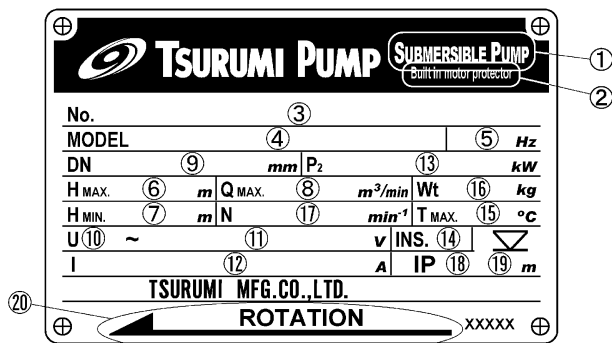
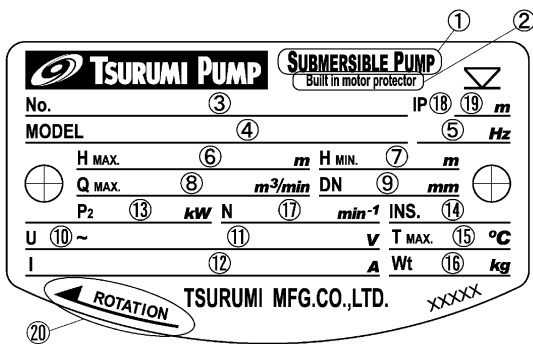

3 INSTALLATION

⚠ CAUTION

- Do not use the pump for pumping liquids other than plain water, such as oil, salt water, or organic solvents.
- Use with a power supply voltage tolerance within $\pm 5\%$ of the rated voltage.
- Use the pump at the water temperature of between 0 and 40°C.
- Failure to observe these precautions could cause the pump to malfunction, which may lead to current leakage or electrical shock.

Note: To use the pump for a special solution, contact the dealer where the pump was purchased, or the Tsurumi sales office in your area.

▀ Preparation for Installation

Listed below are tools and instruments that are needed to install the submersible pump for general dewatering purpose.

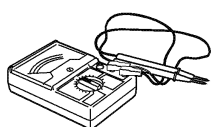

AC voltmeter (tester)

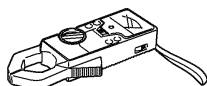

AC ammeter (clamp)

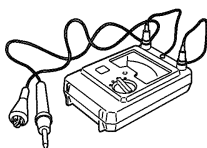

Insulation resistance tester (megger tester)

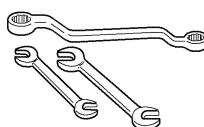

Wrenches for fastening bolts and nuts

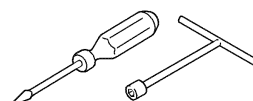

Wrenches for connecting the power supply (a screwdriver or a box wrench)

Note: Consult the operation manual provided with each tester for the proper use of the tester.

▀ Pre-Installation Check

Using a megger tester, measure the resistance between each of the core wires and the ground wire (green or green/yellow) to verify the insulation resistance of the motor.

■ Insulation resistance reference value = 20MΩ min.

Note: The insulation reference value of 20MΩ min. is based on a new or repaired pump. For reference values of a pump that has already been installed, refer to "6. Maintenance and Inspection".

▀ Precautions During Installation

⚠ WARNING When installing the pump, be mindful of the pump's center of gravity and weight. If the pump is not suspended properly, the pump may fall and break, which may lead to injury.

⚠ CAUTION When installing or moving the pump, never suspend the pump by the cabtyre cable. Doing so will damage the cable, which may cause a current leakage, electrical shock, or fire.

Refer to the installation examples illustrated below and pay attention to the points described below to install the pump.

⚠ CAUTION During piping work if the welding sparks, paint, or concrete come in contact with the pump, they could cause the pump to malfunction, which may lead to current leakage or electrical shock.

■ Free Standing Specification

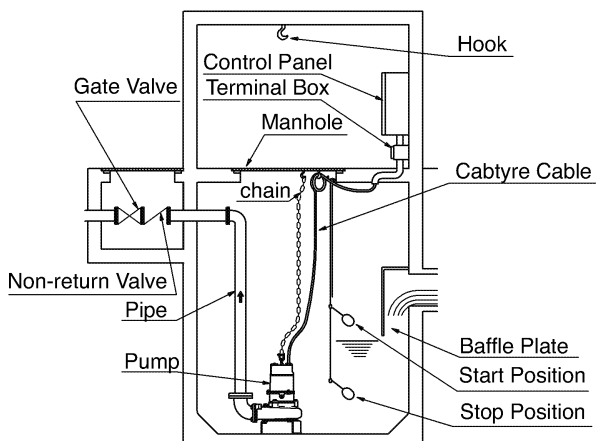

■ Guide-Rail Specification

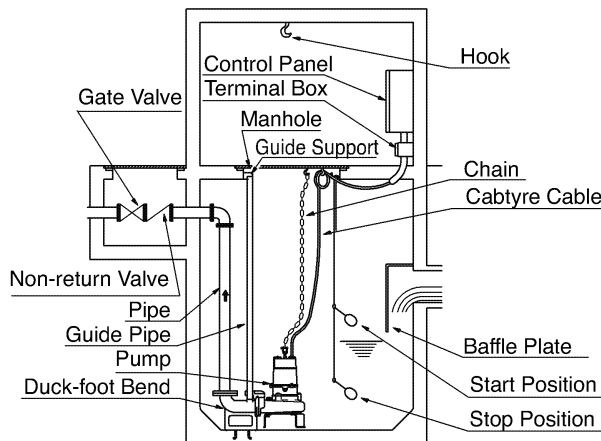

- (1) When transporting or installing the pump, do not kink the cabtyre cable or use it in place of a rope.
- (2) With the cabtyre cable lifted slightly, secure it to the hook (a hook must be prepared in advance by placing it on the frame of a manhole or the like).

CAUTION Do not operate the pump with the cabtyre cable dangling. Failure to observe this precaution may cause the cabtyre cable to become wrapped around the impeller, which could cut the cable, break the impeller, or cause flooding, which may lead to current leakage or electrical shock.

- (3) Install the pump on a horizontal and rigid surface such as concrete, in an area that is free from turbulence and does not cause the pump to take air in.
- (4) The area near the inlet of a water tank is susceptible to turbulence or allows the pump to take air in; therefore, place the pump and the float switch away from the inlet or install a baffle plate.
- (5) Properly perform piping work so as not to create any air pockets in the middle of piping.

CAUTION With automatic control, the sewage water in the pipe could flow backwards, causing the water surface control to react immediately. As a result, the pump will operate ON/OFF repeatedly, which could cause the pump to malfunction.

- (6) Install a non-return valve if the pump tank is deep, or if the vertical head or the lateral distance is long.

Note: To use the pump with the guide rail, refer to the separate operation manual entitled "Guide Rail".

Attaching a Chain or Rope to Suspend the Pump

Refer to the illustration on the right in order to suspend the pump by a chain or rope.

CAUTION Make sure that the rope does not become twisted during installation. Failure to observe this precaution could cause the chain to break and the pump to fall and break, which could lead to injury. When you mount shackles, be also careful so that the eye-bolt (pin) may not get dislocated, by means of providing a stainless steel wire or tying band.

■ Suspending with a rope

■ Suspending with a chain

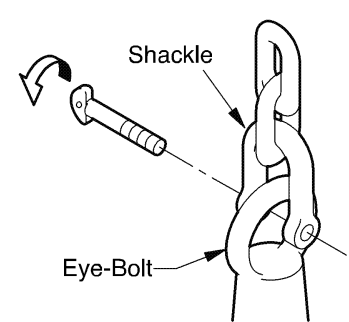
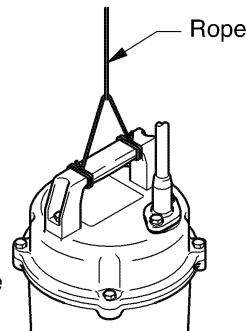

Using a hose for piping

- (1) When a hose is used, attach the hose to the hose coupling as far as it will go, then fasten it securely with a hose band.

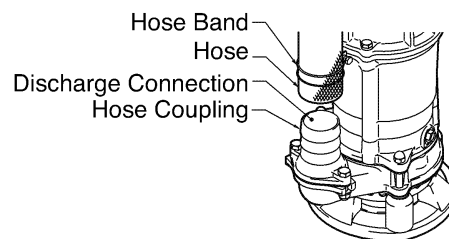

- (2) Operate the pump in a location that has a sufficient water level and collects water easily.

Note: For the water level required for operating the pump, refer to the external dimension drawing, which is provided separately.

Extend the end of the hose (discharge side) above the water surface. If the end of the hose is submerged in water, it may cause the water to flow back when the pump has been stopped. Conversely, if the end of the hose is located at a level that is lower than the source water surface, water may continue to flow out even after the pump has been stopped.

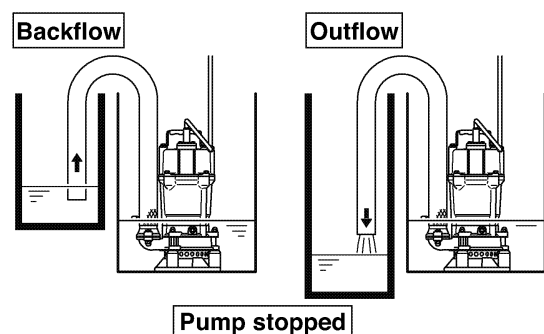

- (3) Route the hose as straight as possible. Excessive bending of the hose could obstruct the flow of water, reduce the pumping volume, or clog the pump with mud, thus disabling the pumping function. If the hose is kinked at its base, it will create air pockets in the pump, making the pump operate dry. To prevent this from occurring, straighten the bend while operating the pump.

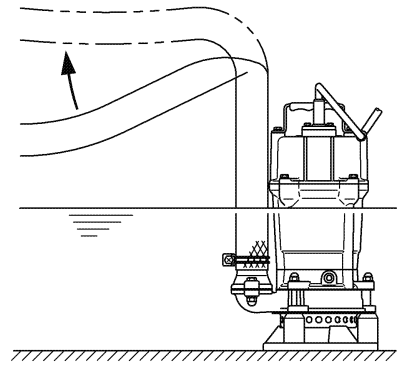

■ Using a hard piping

⚠ CAUTION

Avoid dry operation, which will not only lower performance but can cause the pump to malfunction, leading to electrical leakage and shock.

⚠ CAUTION

When the pump is installed at a work site, make sure the hose is connected in such a way as to ensure proper drainage. Otherwise water may leak out and cause damage to surrounding walls or flooring, or to equipment.

- (2) Install the pump in a location with sufficient water level, where water collects readily.

⚠ CAUTION

Using a pump with insufficient head or operating with a clogged strainer stand can cause excessive vibration and noise, which may result in damage to the pump, electrical leakage and shock.

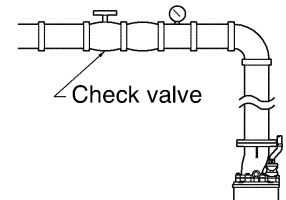
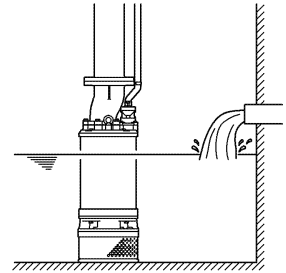

- (3) Run the piping as straight as possible, and avoid having the piping load applied directly to the pump.
- (4) The piping should be able to withstand the recoil when the pump is started up.
- (5) On the flange specification and water depth pressure resistance, see the chart on maximum allowable water pressure.
- (6) If the actual pump head (vertical lift) is high, install a check valve along the piping path.
- (7) Install the piping in such a way that it can be dismantled readily from outside.
- (8) Arrange the piping so that air will not collect in it.
- (9) When performing pipe construction, make sure welding sparks or paint do not contact the pump.

Note: *This pump is supplied without piping. Use it with suitable piping material. The tip of the hose (discharge end) should be located higher than the water surface. If the end of the hose is submerged, water may flow back to the pump when the pump is stopped; and if the hose end is lower than the water surface, water may overflow when the pump is turned off.*

- (10) Use the pump in the upright position and on a flat surface. To prevent the pump from becoming submerged in mud, mount it on a block or other firm base if necessary.

The pump is stopped

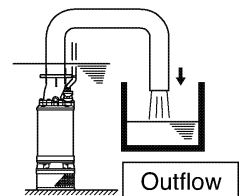
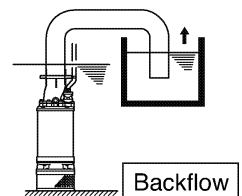

4 ELECTRICAL WIRING

Electrical Wiring Work

⚠️ WARNING

- All electrical work must be performed by an authorized electrician, in compliance with local electrical equipment standards and internal wiring codes. Never allow an unauthorized person to perform electrical work because it is not only against the law, but it can also be extremely dangerous.
- Improper wiring can lead to current leakage, electrical shock, or fire.
- Absolutely provide a dedicated earth leakage circuit breaker and a thermal overload relay suitable for the pump (available on the market). Failure to follow this warning can cause electrical shock or explosion when the product fails or an electrical leakage occurs.

Operate well within the capacity of the power supply and wiring.

Grounding

⚠️ WARNING

Be sure to install the ground wire securely. Failure to observe this precaution could damage the pump and cause current leakage, which may lead to electrical shock.

⚠️ CAUTION

Do not connect the ground wire to a gas pipe, water pipe, lightning rod, or telephone ground wire. Improper grounding could cause electrical shock.

Connecting the Power Plug

⚠️ WARNING

Before inserting the power plug or connecting the wires to the terminal board, make sure that the power supply (i.e. circuit breaker) is properly disconnected. Failure to do so may lead to electrical shock, short, or injury caused by the unintended starting of the pump.

⚠️ CAUTION

Do not use damaged cable cables, power plugs, or loose power outlets. Failure to observe this precaution could lead to electrical shock, short circuit, or fire.

Follow the diagram on the right to connect the power.

When using a three-prong grounded plug, connect as shown in the drawing.

⚠️ CAUTION

Be sure to use a dedicated power supply with a ground leakage circuit breaker.

(This diagram shows a 2-pin plug type.)

⚠️ CAUTION

Beware that the power plug varies by country or region.

Note: *The shape of the plug may differ from that shown in the illustration.*

When a single-phase power source is used, connect the leads to the control panel terminals as shown in the diagram, making sure they do not become twisted together.

When a three-phase power source is used, connect the leads to the control panel terminals as shown in the diagram, making sure they do not become twisted together.

With a star delta start model, connect the cable U1, V1, W1, U2, V2, W2 and ground leads to the respective terminals.

If a miniature protector, water leak sensor or other control circuit is used, be sure to connect them to the intended circuitry.

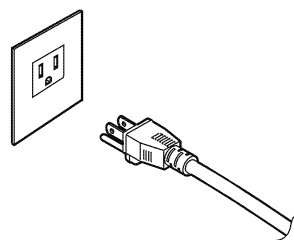

Single Phase

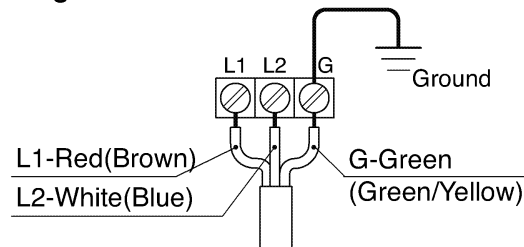

Three Phase

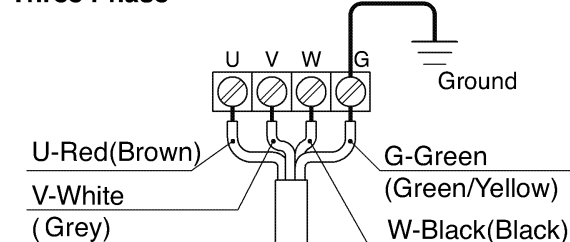

■ Cabtyre cable



CAUTION

- If it is necessary to extend the cabtyre cable, use a core size equal to or larger than the original. This is necessary not only for avoiding a performance drop, but to prevent cable overheating which can result in fire, electrical leakage or electrical shock.
- If a cable with cut insulation or other damage is submerged in the water, there is a danger of water seeping into the motor causing a short. This may result in damage to the product, electrical leakage, electrical shock, or fire.
- Be careful not to let the cabtyre cable be cut or become twisted. This may result in damage to the product, electrical leakage, electrical shock, or fire.
- If it is necessary to submerge the connection leads of the cabtyre cable in water, first seal the leads completely in a molded protective sleeve, to prevent electrical leakage, electrical shock, or fire.

Do not allow the cabtyre cable leads to become wet.

Make sure the cable does not become excessively bent or twisted, and does not rub against a structure in a way that might damage it.

5

OPERATION

Before Operation



CAUTION

Improper voltage and frequency of the power supply will prevent the pump from attaining its full potential, and may also lead to current leakage, electrical shock, or fire.

- (1) Once again, check the nameplate of the pump to verify that its voltage and frequency are correct.
- (2) Check the wiring, power supply voltage, the capacity of the ground leakage circuit breaker, and the insulation resistance of the motor.

■ Insulation resistance reference value = 20MΩ min.

Note: *The insulation reference value of 20MΩ min. is based on a new or repaired pump. For reference values for a pump that has already been installed, refer to "6. Maintenance and Inspection".*

- (3) Adjust the setting of the overflow protector (i.e. circuit breaker) to the pump's rated current.

Note: *Verify the rated current on the pump's nameplate.*

- (4) When using a generator, as much as possible avoid operating the pump in conjunction with other types of equipment.

Test operation



WARNING

- Never operate the pump while it is suspended in the air. The recoil may result in injury or other major accident.
- Never start the pump when people are standing next to it. An electrical leak can result in electrical shock.

- (1) Run the pump for a short time (1~2 seconds) to check the direction of rotation. The rotation is correct if the pump recoil direction is counter-clockwise.



CAUTION

Always perform the rotation check in air, not while the pump is submersed. Running the pump in reverse direction while submersed may damage the pump, resulting in electrical leakage or electrical shock.

- (2) If the direction is reversed, correct it using the countermeasure shown below.



WARNING

Before changing the connections to correct the rotation, be sure to turn off the power supply (circuit breaker), and make sure the impeller has stopped completely, to avoid electrical shock or shorting.

COUNTERMEASURE

(Direct-on-line start models):
Interchange connections between any two of the three leads U, V, or W.

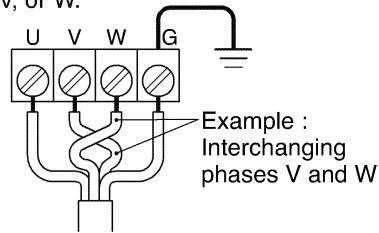

COUNTERMEASURE

(Star-delta start models):
Interchange connections between any two of the three leads R, S, or T.

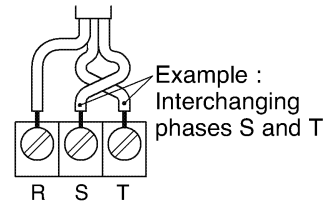

- (3) Run the pump for a short time (3~10minutes) and confirm the following.
Using an ammeter(clamp-on type), measure the operating current at the U, V, and W phase leads on the terminal strip.

COUNTERMEASURE

If the operating current exceeds the rated value, pump motor overload may be a cause. Make sure the pump has been installed under proper conditions as described in the section on Installation
Using an AC voltmeter(tester), measure voltage at the terminal strip.
■ Power supply voltage tolerance = within $\pm 5\%$ of the rated voltage

COUNTERMEASURE

If the supply voltage is outside the tolerance, possible causes are the power supply capacity or an inadequate extension cable. Look again at Electrical Wiring and make sure the conditions are proper.

CAUTION In case of very excessive vibration, unusual noise or odor, turn off the power immediately and consult with your nearest dealer or Tsurumi representative. Continuing to operate the pump under abnormal conditions may result in electrical shock, fire, or electrical leakage.

- (4) If the test operation turns up no problems, continue with full operation.

Operation

WARNING The pump unit may be extremely hot during operation. To prevent burns, do not touch the pump unit with bare hands during or after an operation.

Pay attention to the water level during the pump operation. The pump may become damaged if it is allowed to operate dry.

Due to an overload operation or a pump malfunction, if the motor protector trips to stop the pump, make sure to eliminate the cause of the problem before restarting.

Note: A large amount of amperage flows when a submersible pump is started, causing the temperature of its windings to rise rapidly. Beware that a frequent stop-and-go operation of the pump will accelerate the deterioration of the insulation of the motor windings, and thus affect the use life of the motor.

Motor protection system



WARNING

During inspections or repairs, always be sure to turn off the power. Sudden unexpected starting of the pump can cause electrical shock, shorting, or serious injury.



CAUTION

- Always determine the cause of the problem and resolve it before resuming operation. Simply repeating cycles of stopping and restarting will end up damaging the pump.
- Do not continue operation at very low water level, or while the strainer stand is clogged with debris. Not only will performance suffer, but such conditions may cause noise, heavy vibration, and malfunctioning.

1. Circle Thermal Protector

If an excessive current is detected or the motor overheats, for reasons such as the following, the pump will automatically stop operating regardless of the water level, to protect the motor.

- Change in supply voltage polarity
- Overload
- Open-phase operation or operation under constraint

2. Miniature Protector

This protector is embedded inside the motor coil. If the coil should overheat for any reason, bending of the bimetal of the miniature protector triggers a signal, which in turn causes an external circuit in the starting console or control panel to shut off the motor current. When the temperature returns to normal, the protector is automatically reset, but restarting is controlled from the starting console or control panel.

Note: *A b-contact miniature protector is adopted, which is normally "closed" and goes to "open" upon overheating. To protect the motor from current surges, be sure to install a motor breaker, thermal relay or similar device in the external starting console or control panel. A 3E relay is able to protect the motor from overload, open-phase or reverse-phase operation.*

3. Water Leak Sensor

Pump models with output of 55kW or greater have a water leak sensor electrode in the oil compartment. If water leaks into the oil compartment, the electrode signal is detected by an amplifier (floatless switch), triggering the shutoff of the motor current at the external starting console or control panel. If this detector should operate, the pump will need to undergo internal repairs.

Note: *Use a floatless switch as the signal amplifier. To prevent the protector from operating due to an induced current, the external starting console or control panel should be configured to switch off the motor only after the leak sensor signal continues for several seconds.*

Automatic Operation

Trial Operation

Equipped with floats to detect the water level and an internal control circuit, the automatic type (...A) pump can perform an automatic drainage operation alone by merely connecting its cable to a power supply. Connect the power and perform a trial operation as follows:

- (1) Direct all the floats downward.
- (2) First raise the (red) stop float, then the (yellow) start float. This will cause the pump to start.
- (3) Next, return the (yellow) start float, and then the (red) stop float to their original positions. This will cause the pump to stop.
- (4) Perform steps (2) and (3) consecutively two or more times to verify the operation.

Check float switch operation

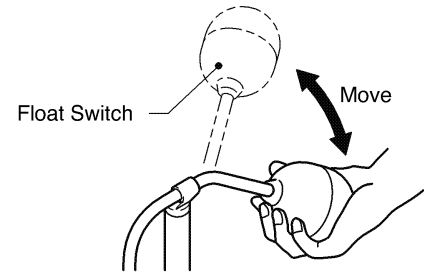

Note: Allow the pump to operate a minimum of 2 seconds for each trial operation. The trial operation must be completed within 1 minute.

⚠ CAUTION

In case the pump exhibits an abnormal condition (such as a considerable amount of vibration, noise, or smell), disconnect the power supply immediately and contact the dealer where you purchased the equipment, or Tsurumi's sales office in your area. If the pump continues to be used in the abnormal state, it may cause current leakage, electrical shock, or fire.

Automatic Alternating Operation

Trial Operation

The (...W) automatic alternating type pump is used in conjunction with the (...A) automatic type. Equipped with floats to detect the water level and an internal control circuit, it can perform an automatic alternating drainage operation by merely connecting its cable to a power supply. Connect the power and perform a trial operation as follows:

- (1) Direct all the floats downward.
- (2) First raise the (red) stop float, then the (yellow) alternating start float.
- (3) Next, return the (yellow) alternating start float, and then the (red) stop float to their original positions. This will cause the pump to stop.
- (4) Perform steps (2) and (3) consecutively three or more times to verify the operation. The pump will start and stop every other time.
- (5) Again, direct all the floats downward.
- (6) After performing the trial operation of pump by the step (2) and (3). Raise the (red) stop float, then the (yellow) alternating start float, and the (green) parallel operation float. This will cause the pump to start.
- (7) Next, return the (green) parallel operation float, then the (yellow) alternating start float, and then the (red) stop float to their original positions. This will cause the pump to stop.
- (8) Perform steps (6) and (7) consecutively two or more times to verify the operation.

Check float switch operation

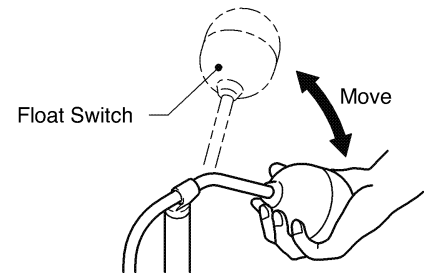

Note: It takes approximately 1 second for the pump to start after the float is moved. Allow the pump to operate a minimum of 2 seconds for each trial operation. The trial operation must be completed within 1 minute.

⚠ CAUTION

In case the pump exhibits an abnormal condition (such as a considerable amount of vibration, noise, or smell), disconnect the power supply immediately and contact the dealer where you purchased the equipment, or Tsurumi's sales office in your area. If the pump continues to be used in the abnormal state, it may cause current leakage, electrical shock, or fire.

6 MAINTENANCE AND INSPECTION

Regular maintenance and inspections are a necessity for continued efficient functioning of the pump. If any abnormal conditions are noticed, refer to the section "7.Troubleshooting" and take corrective measures immediately. It is recommended that a spare pump be kept ready in case of any problems.

Prior to inspection

⚠ WARNING Detach the cable from the receptacle or terminals, after making certain the power supply (circuit breaker, etc.) is turned off. Failure to follow this precaution may result in a serious accident from electrical shock or unexpected starting of the pump motor.

- (1) Washing the pump
Remove accumulated matter from the surface of the pump and wash it with clean water. Take special care to remove any debris from the impeller.
- (2) Inspecting the pump exterior
Look for any peeling or chipped paint, and make sure the nuts and bolts are fastened tightly. Any cracks in the surface should be repaired by cleaning that area, drying it and then applying a touchup coating.

Note: *Touchup is not supplied. Note that some kinds of damage or looseness may require that the unit be disassembled for repairs. Please consult with your nearest dealer or Tsurumi representative.*

Regular Inspection

Interval	Inspection Item
EveryDay	<ul style="list-style-type: none"> ■ Measure operating current ● To be below the rated current ■ Measure power supply voltage ● Power supply voltage tolerance (within ±5% of the rated voltage)
Monthly	<ul style="list-style-type: none"> ■ Measuring insulation resistance ● Insulation resistance reference value = 1MΩ min. <i>Note: The motor must be inspected if the insulation resistance is considerably lower than that obtained during the last inspection.</i> ■ Pump inspection ● A noticeable drop in performance may indicate wear in the impeller etc., or else clogging of the strainer stand, etc. Remove the clogged debris, and replace any worn parts.
Semi-yearly	<ul style="list-style-type: none"> ■ Inspection of lifting wire rope or chain ● Replace if damage, corrosion, or wear has occurred to the wire rope or the chain. Remove if foreign object is attaching to it. ■ Inspecting oil ● Check the oil every 6 months or after 3,000 hours of use, whichever comes first.
Yearly	<ul style="list-style-type: none"> ■ Change oil ● Change the oil every 12 months or after 6,000 hours of use, whichever comes first. Designated oil: Turbine oil VG32, Liquid Paraffin VG15 or VG32. ■ Change mechanical seal <i>Note: Contact the dealer from whom you purchased the equipment, or the Tsurumi sales office in your area to inspect and replace the mechanical seal.</i>
Every 2 to 5 years	<ul style="list-style-type: none"> ■ Overhaul ● The pump must be overhauled even if the pump appears normal during operation. The pump may need to be overhauled earlier if it is used continuously or repeatedly. <i>Note: Contact the dealer from whom you purchased the equipment, or the Tsurumi sales office in your area to overhaul the pump.</i>

Note: *In case the pumping liquid contains oil, paint, or slurry, it may cause the swelling of cable jacket or abrasion of the mechanical seal's sealing face, which will result in the pump fault, it is strongly recommended to inspect earlier.*

Storage

When the pump is out of use for an extended period, wash it and dry it thoroughly, then store it indoors.

Note: *Always run a test operation before putting the pump back into service.*

When the pump is left installed in water, it should be run at regular intervals (about once a week).

7 TROUBLESHOOTING

⚠ WARNING To prevent serious accidents, disconnect the power supply before inspecting the pump.

Read this Operation Manual carefully before requesting repair. After re-inspecting the pump, if it does not operate normally, contact the dealer where this equipment was purchased, or the Tsurumi sales office in your area.

Problem	Possible cause	Countermeasure
Pump fails to start; or, starts but stops immediately.	(1)No proper power is supplied (i.e. power outage). (2)Malfunction in automatic control (control panel) (3)Foreign matter is wedged in the propeller, causing the motor protector to trip. (4)Damaged motor. (5)Open circuit or poor connection of cabtyre cable. (6)Voltage drop due to the extension of cabtyre cable. (7)Malfunction in start float.	(1>Contact the electric power company or an electrical repair shop. (2)Have the cause investigated and repaired by a specialist. (3)Inspect the pump and remove the debris. (4)Repair or replace. (5)Replace or properly connect the cabtyre cable. (6)Shorten the extension cable or replace it with one with a larger size. (7)Remove obstacles and check the operation of the stop float.
Motor protector trips.	(1)Malfunction of motor (seizure or water damage). (2)A 50Hz unit is used at 60Hz. (3)Liquid temperature is too high. (4)Pump has been operating for a long time while being exposed to air. (5)Amperage overload. (6)The movement of the stop float is obstructed, causing the start float alone to perform the start and stop operations.	(1)Repair or replace. (2)Check the nameplate and replace the pump. (3)Lower the liquid temperature. (4)Stop the pump; then lower the water level. (5)Refer to the section on amperage overload. (6)Remove obstacles and check the operation of the stop float.
Pump operates but does not pump water.	(1)An air lock occurred in the pump. (2)The pump or the piping is blocked. (3)The piping is partially blocked or the valve is operating improperly. (4)The motor rotates in reverse.	(1)Stop momentarily and then restart; or, clean the air release valve. (2)Remove the blockage. (3)Remove the blockage, or repair or replace the valve. (4)Change the power supply connection.
Low pumping volume.	(1)The impeller or the pump casing is significantly worn. (2)Excessive piping loss. (3)Operating water level is too low, allowing pump to draw in air. (4)A 60Hz pump is used at 50Hz. (5)There is a leak in the piping. (6)The piping or the pump is clogged with debris.	(1)Repair or replace the affected part. (2)Re-examine the work plan. (3)Raise the water level or lower the pump position. (4)Check the nameplate and replace the pump. (5)Inspect and repair. (6)Remove the debris.
Amperage overload.	(1)Excessive imbalance in the power supply voltage. (2)Excessive voltage drop. (3)Phase interruption. (4)A 50Hz pump is used at 60Hz. (5)Motor rotates in reverse. (6)Pump is clogged with debris. (7)Motor bearing is damaged.	(1)Contact the electric power company or an electrical repair shop. (2)Contact the electric power company or an electrical repair shop. (3)Inspect the connections and the magnetic switch. (4)Check the nameplate and replace the pump. (5)Change the connection of the power wires. (6)Remove the debris. (7)Disassemble the motor and replace the bearing.
The pump does not stop automatically.	(1)The movement of the start and stop floats is obstructed. The switch in a float is faulty. (2)The water level of the stop float is set lower than the pump's minimum possible operating water level.	(1)Remove the blockage. Or, replace the part. (2)Set the water level of the stop float higher than the pump's minimum possible operating water level.
The pumps do not perform proper alternating operation.	(1)The float switch is not set to the proper water level. (2)One of the pumps is malfunctioning.	(1)Set it to the proper water level. (2)Repair or replace the pump.
Not possible to raise the pump (Guide-rail fitting Type)	(1)Mating flange of the duckfoot bend and pump discharge flange went rusty. (2)Guide hook being seized by the guide rails. (3)Cable(s) or Chain get stuck by something.	(1)Shake the chain mildly, and lift the unit slowly. (2)loosen the chain slightly, and lift slowly while shaking it slightly. (3)Free the point that gets stuck.

The following information is required when ordering repairs or making other inquiries.

Product model	
Manufacturing number	
Purchase date	
Remarks	

Disposal of Product

Properly dispose of the product by disassembling it, presorting the contents, and sending them to the waste material treatment site.